

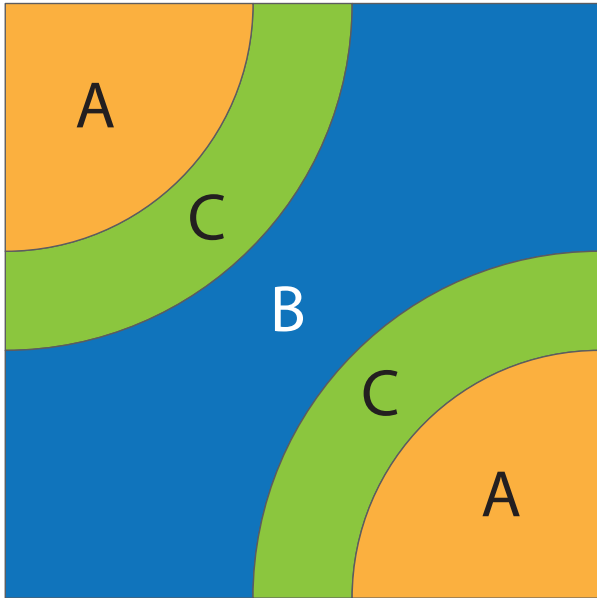

GO!® Signature Circles-6" Finished

Item Number: 55624

Fabric Cutting Tips for one 3-color, 6" finished Signature Circles block:



Place fabric over shapes then run through the cutter:

For best cutting results, position fabric on the lengthwise grain (straight of grain) as it goes under the roller. Tip: The die is specially designed to cut one complete 3-color, 6" finished block in one pass through the cutter.

- **Fabric Color 1 (orange):** Cut two 3½" squares. Place right side up over shape A to cut 2 shapes.
- **Fabric Color 2 (blue):** Cut one 7" square. Place right side up over shape B to cut 1 shape.
- **Fabric Color 3 (green):** Cut two 4½" squares. Place right side up over shape C to cut 2 shapes.

Shapes needed for 6" finished Signature Circles

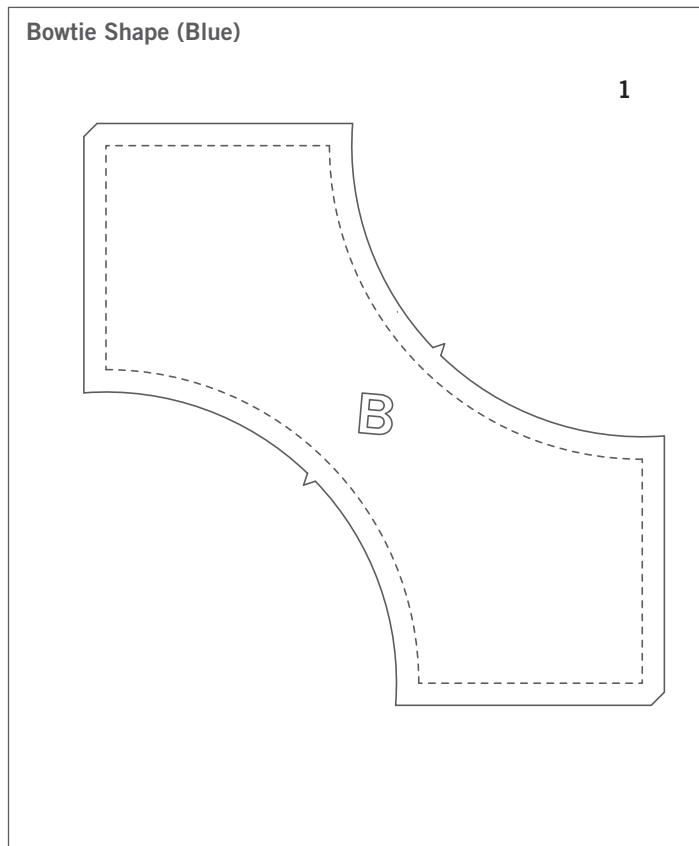
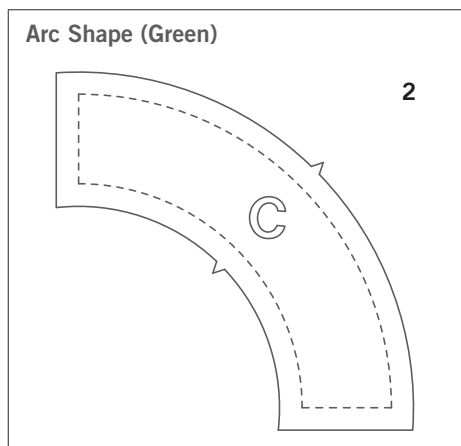
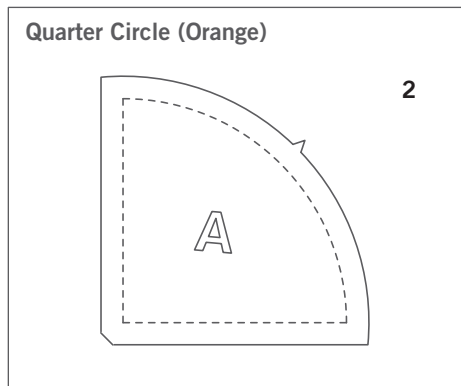



GO!® Signature Circles-6" Finished

Item Number: 55624

How to Sew 3-color, 6" and 12" finished Signature Circles Blocks:

The How to Sew instructions show you how to assemble the 6" and 12" finished blocks. Use a consistent 1/4" seam allowance and stretch or ease fabrics as needed to ensure a smooth seam. Press seams as directed in your pattern.

Step 1

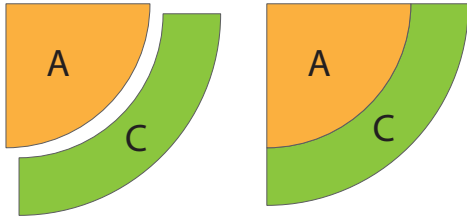

Sew A shape to C shape. Hint: Lay C concave shape on top of A convex shape, right sides together, match up notches and pin. Aligning raw edges, match corners and pin as needed to ensure a smooth seam. Make 2 units.

Step 2

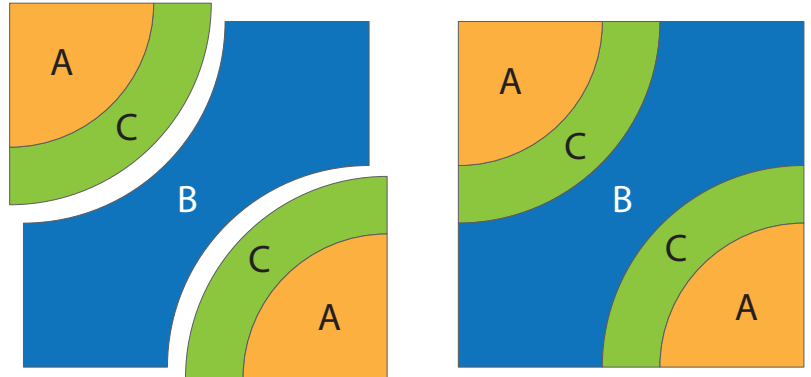

Sew an A/C unit to either side of B shape, matching up notches and sewing with B concave unit on top as it goes under needle. Block should measure 6 1/2" x 6 1/2".

Step 3

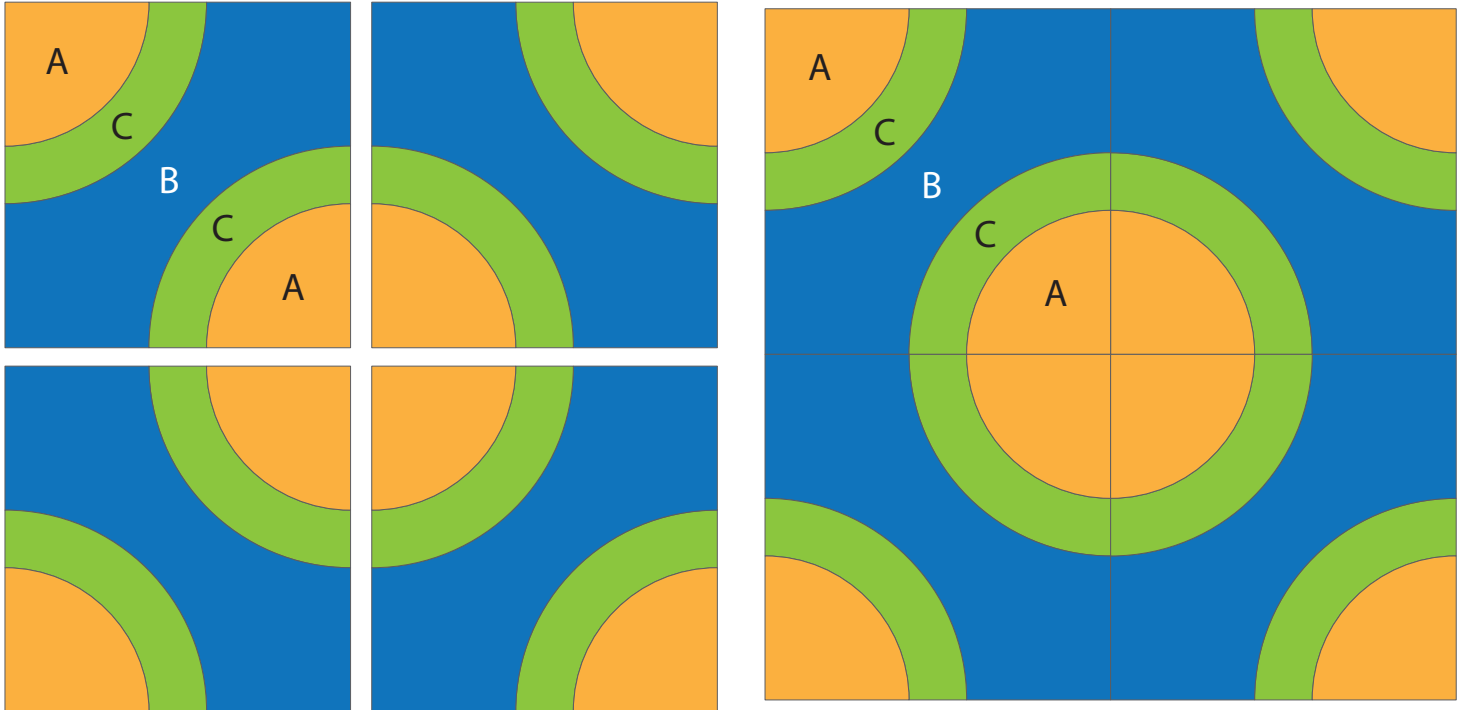

To create a 12" finished block, lay out four units as shown. Sew units into rows. Sew rows together to make a complete block.



GO!® Signature Circles-6" Finished

Item Number: 55624

Signature Circles Quilt Block Coloring Page

Print out and color as desired to test out different color and fabric combinations.

