

DIRECTIONS

To Cut Strips:

1. Fold fabric selvage to selvage.
2. Fold again in same direction.
3. Lay Shape Cut™ over fabric, with raw edges extending slightly beyond vertical slot marked "0" and bottom fold of fabric at horizontal line marked "0".
4. To square up raw edge of fabric, insert blade in "0" slot marking and cut.
5. Cut subsequent strips to desired width.

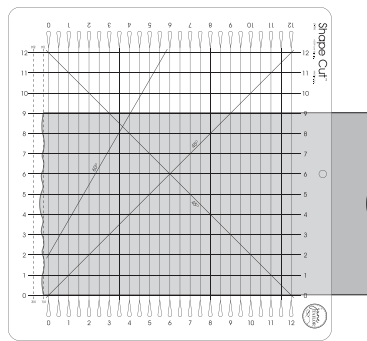

To Cut Squares:

1. Cut strips in desired width following previous instructions.
2. Keeping cut strips intact, lift Shape Cut and turn 90°.
3. Cut desired width in opposite direction.

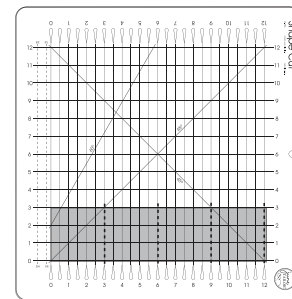

To Cut Bias Strips:

1. Fold fabric in half diagonally.
2. Line up fold with "0" horizontal marking on Shape Cut.
3. Cut strips in desired widths.

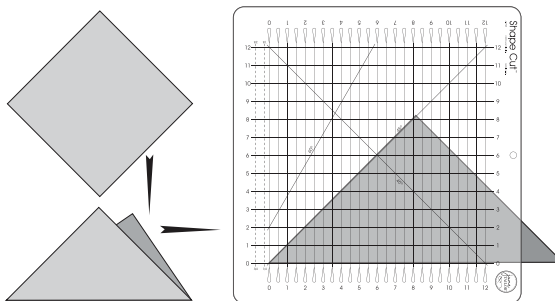

To Cut Triangles:

1. Line up corner of square under 45° markings on Shape Cut.
2. Cut in half using slot marking that runs through center of square.

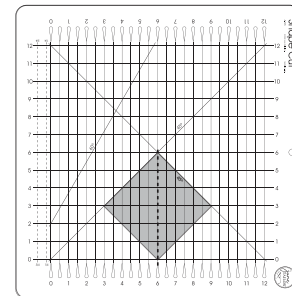

To Cut 1/4" and 3/4" Increments:

1. After squaring up raw edge of fabric, re-align cut edge with the 1/4" or 3/4" dashed line.
2. Cut in the inch increment slots for desired width.

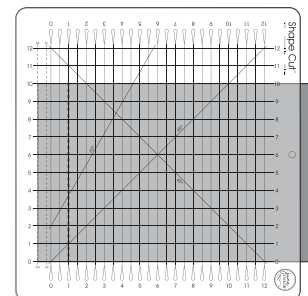

To Cut Chevrons:

1. Fan fold fabric in desired width.
2. Line up folded fabric on either 45° or 60° marking on cutting mat.
3. Cut desired width.

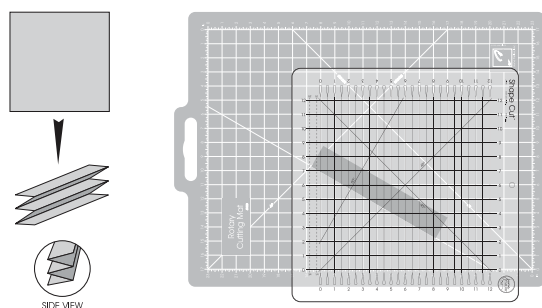

To Cut Diamonds:

1. Cut fabric into strips with desired width.
2. Line up fabric strip on either 45° or 60° marking on cutting mat.
3. Place the Shape Cut ruler on top of fabric strip, align horizontal marking on the ruler with the horizontal lines on the cutting mat.
4. Cut strips in desired width to form diamonds.

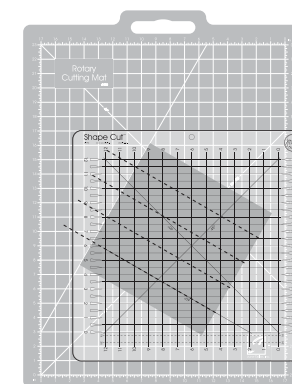
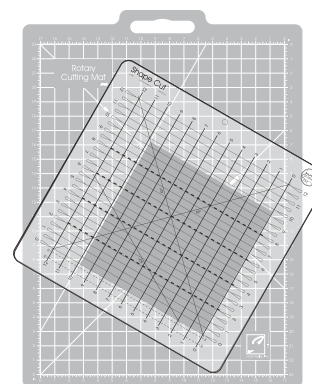

To Cut Hexagons:

1. Cut diamonds using the 60° marking on your rotary cutting mat.
2. Center each diamond horizontally under the number 6 slot on the Shape Cut.
3. Cut half the width of the diamond on each side of the center, number 6, slot opening.

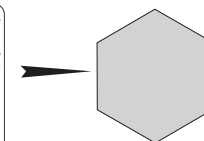
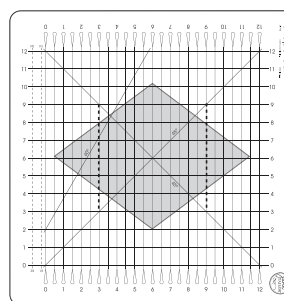

Video Tutorial